

RMS-7790C - CORE EXP 3.0 CLUTCH

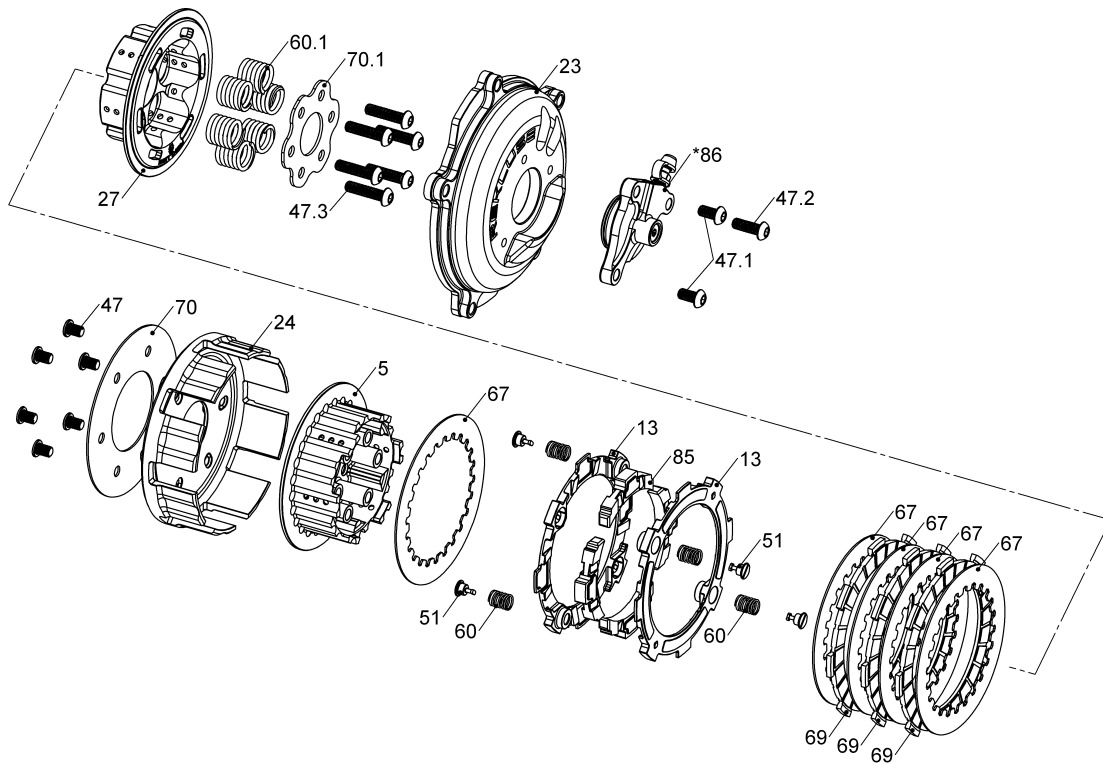

Item	Part Number	Item Description	Qty
5	113-021B	PRESSURE PLATE - Core - KTM65	1
13	140-233C	EXP 3.0 BASE - KT65	2
23	169-987A	CLUTCH COVER - KTM 65cc (2009+)	1
24	170-005A	CLUTCH BASKET - KT65	1
27	178-045B	CENTER CLUTCH - CORE - KT65	1
47	411-130	FASTENER - M6 x 8 Super Low Head Socket Head Cap Screw	6
47.1	411-162A	FASTENER - M6 x 1.0 x 12mm Button Head Hex Screw, Stainl	2
47.2	411-180B	FASTENER - M6 x 1. x 18mm Button-Head Allen Screw, Zinc-	1
47.3	411-181A	FASTENER - M6 x 1.0 x 25mm Button-Head Hex Socket Scre	6
51	415-000	FASTENER - Quarter Turn Pin	4
Not Shown	415-000	FASTENER - Quarter Turn Pin	2
Not Shown	419-121	HARDWARE - 0.5 Black Free Play Gain Rubber Band	1
Not Shown	442-003	EXP ADJUSTMENT SPRING EXP - Blue	2
60	442-004	EXP ADJUSTMENT SPRING EXP - Gold	4
Not Shown	442-005B	EXP ADJUSTMENT SPRING EXP - Green	2

RMS-7790C - CORE EXP 3.0 CLUTCH

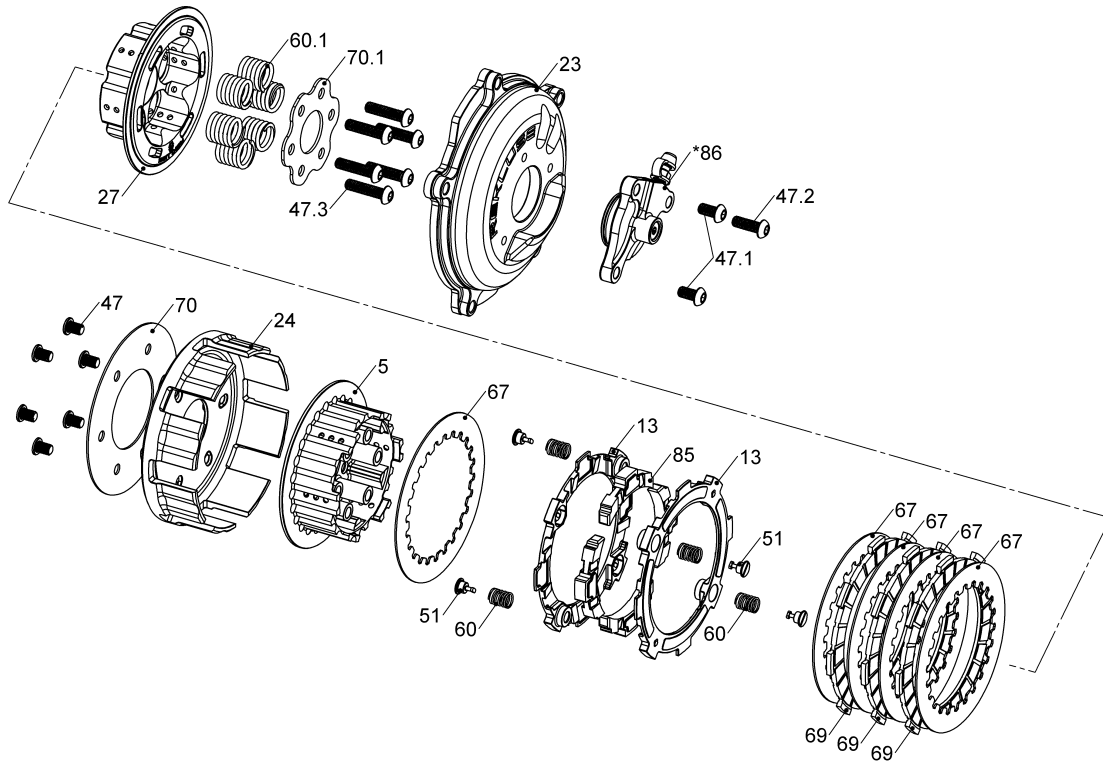

Item	Part Number	Item Description	Qty
60.1	442-127A	PRESSURE PLATE SPRING - 65 ORANGE STRIPE	6
67	465-414A	DRIVE PLATE - 0.040 CORE - KT65	5
69	469-691	FRICITION DISK - K65 Friction Disks	3
70	471-005C	BASKET BACKING PLATE- KT65	1
70.1	471-007B	SPRING PUSH PLATE - KT65	1
Not Shown	471-114	DRILL - 1/4 SM Drill BIT	1
Not Shown	491-001	ADHESIVE - Loctite 243 .02 fl oz	1
85	741-027A	EXP 3.0 WEDGE ASSEMBLY - KT65 - Heavy	4
86	742-020E	ADJUSTABLE SLAVE CYLINDER ASSEMBLY - Housing-119, Pis	1