

RMS-7178B - CORE MANUAL TORQ-DRIVE CLUTCH

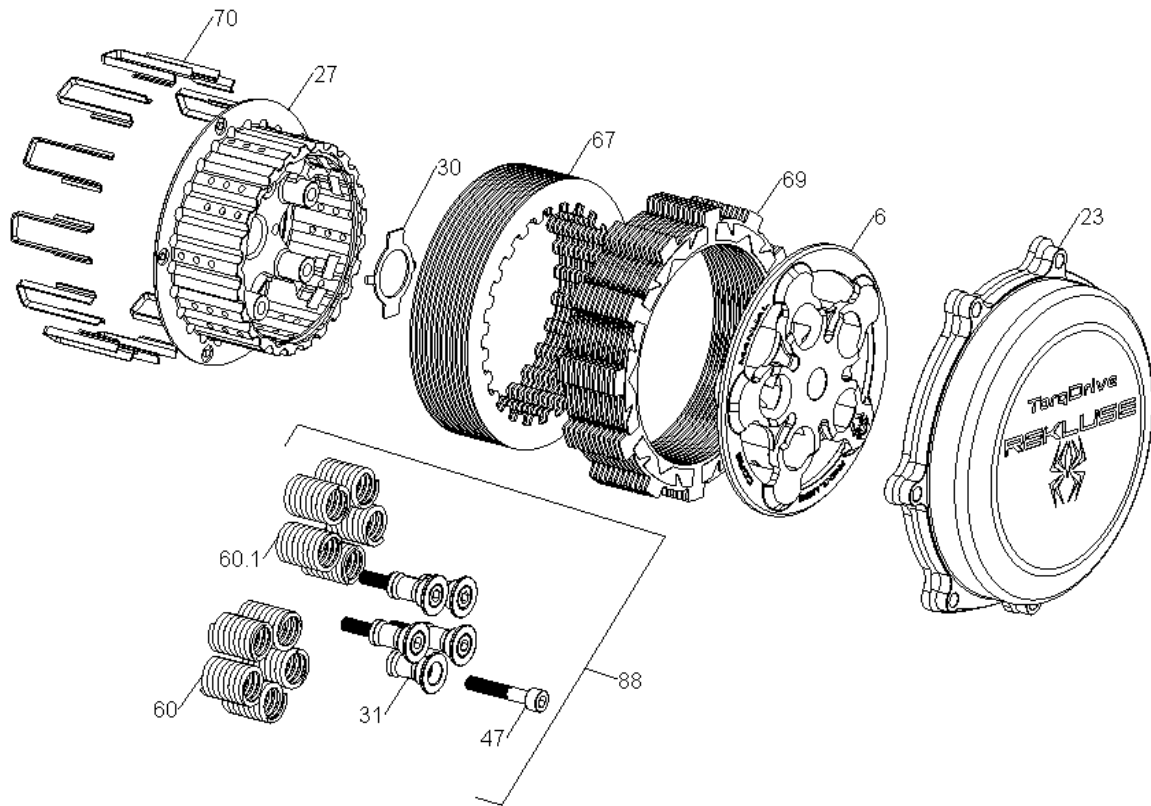

Item	Part Number	Item Description	Qty
6	114-171A	PRESSURE PLATE - Torq Drive - YZ250F	1
23	169-778A	CLUTCH COVER - TorqDrive - YZ250F (14+)	1
27	178-010D	CENTER CLUTCH - CORE EXP/CORE MANUAL - Y250	1
30	183-004A	HARDWARE - Core Center Clutch Tab Lock Washer 27mm S	1
67	465-400B	DRIVE PLATE - 0.040 Core RMS TC250 Precision	12
69	469-304A	FRICTION DISK - H250 TORQ-DRIVE	12
70	471-300	BASKET SLEEVE - Dirt Bikes	12
88	744-006A	TORQ DRIVE SPRING KIT - 250	1
31	184-101B	HARDWARE - EXP Screw Sleeve	5
47	411-140	FASTENER - M6-1 x 35mm Thermal Black Socket Cap Screw	5
60	442-103	PRESSURE PLATE SPRING - 250 Class Bikes Medium Silver	5
60.1	442-104	PRESSURE PLATE SPRING - 250 Class Bikes Heavy Gold	5