

# RMS-2313081D - SLAVE CYLINDER REBUILD KIT

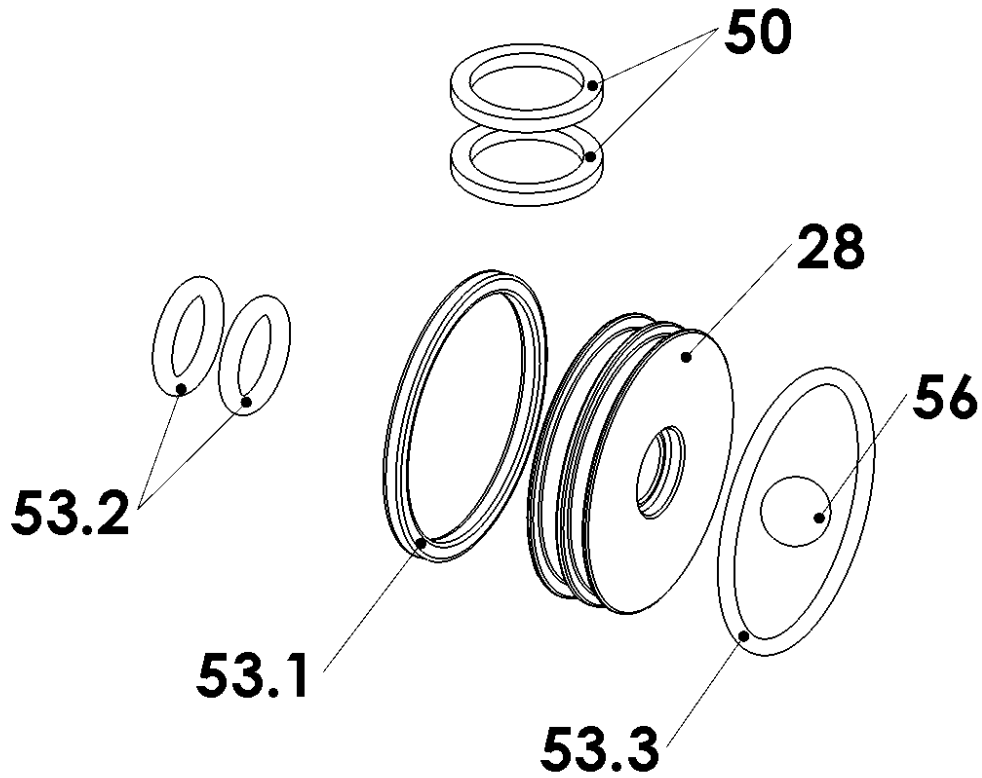

Item	Part Number	Item Description	Qty
28	180-318A	SLAVE CYLINDER PISTON - DIV 1.5 WS	1
50	414-238	HARDWARE - 2 x 8mm Crush Washers	2
53.1	418-804	HARDWARE - 021 EPDM X Ring Black	1
53.2	418-907	HARDWARE - 011 EPDM O-ring	2
53.4	418-915A	HARDWARE - BUNA O-ring, size 30mmID x 1.5mmW, Black	1
53.3	418-917A	HARDWARE - 1.5x24mm Viton O-ring, 75Dur	1
55	420-303A	GASKET - Slave Cylinder - Brembo - fits 180-122	1
56	431-304	BALL BEARING - 1/4in Chrome Steel Ball	1
Not Shown	491-003A	ADHESIVE - Silicone Grease Packet	1
Not Shown	821-013A	Prop. 65 Warning Label	1